

Technical Brochure

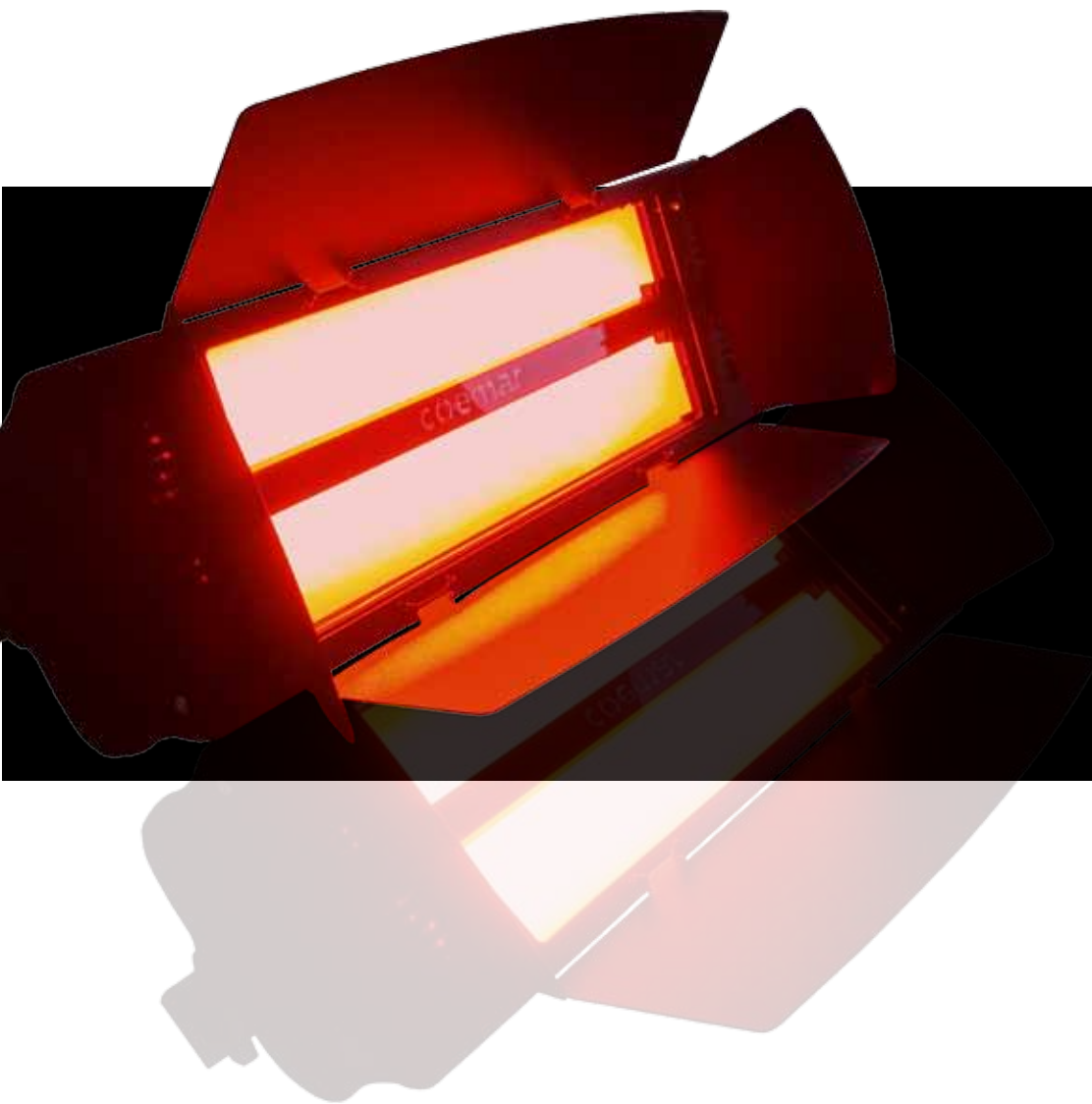

Preview



**SoftLite Led
RGBW**

Lite Led Series

SoftLite Led

RGBW



KEY FEATURES

- RGBW color mixing
- LED soft light, ideal for broadcast segment
- White ranging from 2.700 K to 10.000 K with color rendering index greater than 90 (CRI>90)
- Plus minus green correction
- Color saturation adjustment
- Indirect fully uniform illumination
- Smooth 16 bit dimmer
- Flicker-free operation with LEDs frequency controlled via DMX from 600 Hz to 19000 Hz
- 220 W LED light source
- The fan setting allows three options : low, auto, DMX regulated

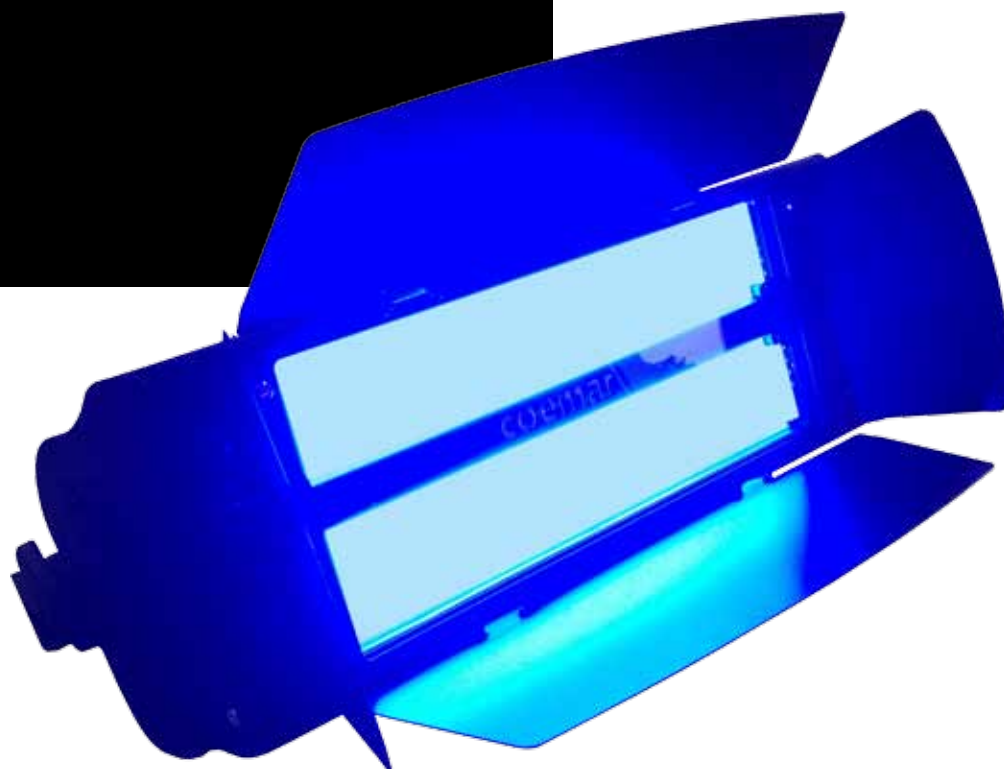



SoftLite Led

SPECIFICATIONS

RGB+W colour mixing with Hue and Saturation control, with pure color mixing throughout the field and all whites from 2700 to 10000 K

Green-Magenta Adjustment

Electronic dimmer from 0% to 100%

Light project angle of 120°

Electronic control of the cooling system

Tempered frontal polycarbonate (UV)

Guaranteed Flicker-free operation, LEDs frequency controlled via DMX from 600 Hz to 19000 Hz

Fan setting with 3 different options (low, auto, DMX regulated)

Aluminium extruded and steel body

Double dissipation system: air forced heat pipe and fan

PHYSICAL SIZE

Length: 208.2 mm (8.2 in)

Height: 602 mm (23.7 in)

Height with bracket: 270.8 mm (10.6 in)

Weight: 9.6 Kg (21.1 lbs)

LIGHT SOURCE

96 Cree LEDs, 24 Red, 24 Green, 24 Blue, 24 White

CONTROL PROTOCOL AND PROGRAMMING

USITT DMX512/1990

Setting, addressing, testing and measurements via LEDs display

Remote Device Management (RDM)

ELECTRICAL SPECIFICATIONS/CONNECTIONS





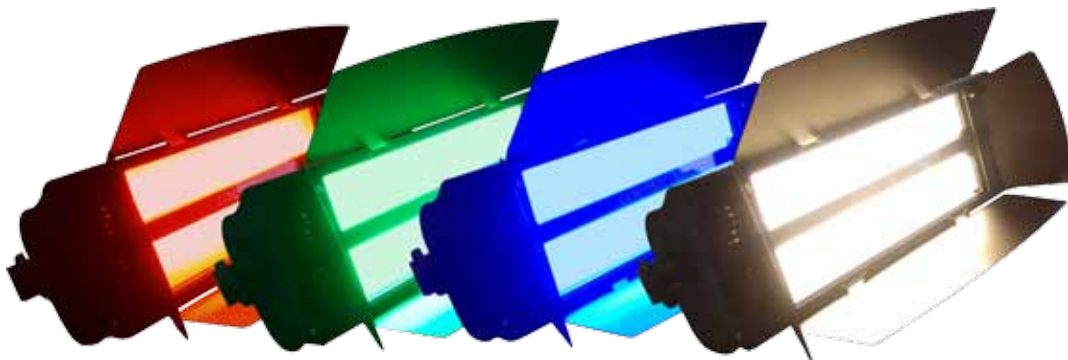

AC power: 90-240V, auto sensing, 50/60 Hz, 2 m (6.6 ft) PowerCon cable without power plug

In and Out PowerCon connectors to feed up to 10 (at 230 VAC) or 5 (90 VAC)

Power consumption: 1.2 A at 230 V, 2.43 A at 115V - $\cos\phi$ 0,9

DMX data in/out: XLR 3 M/F and 5 M/F



Picture	Code	Description
	BC10026A001	Color frame holder
	BC10026A002	4 leaf barndoor
	BC10026A003	Honeycomb (6 mm)
	BC10026A004	Honeycomb (10 mm)
	BC10026A005	Honeycomb XL
	BC10026A006	Soft diffuser (Different filters available)

SoftLite Led - Drawing Size

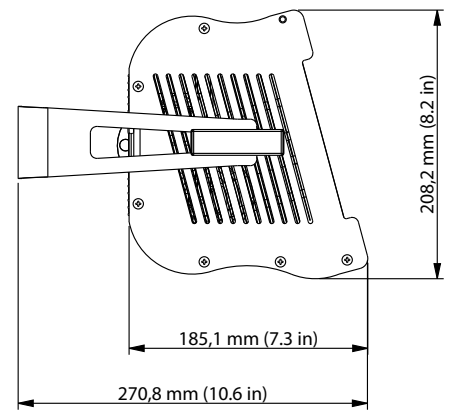
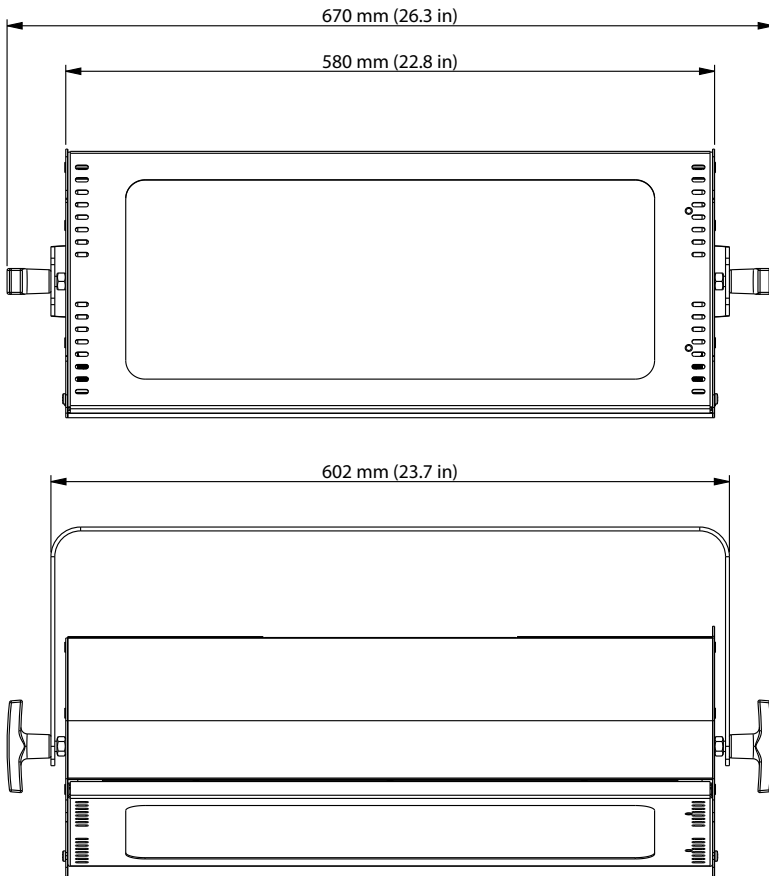

DMX Chart 14 Channels

channel	effect
1	Master dimmer
2	Red
3	Green
4	Blue
5	White
6	Strobe effect
7	Dimmer fine
8	Special functions
9	Red tone
10	Green tone
11	Blue tone
12	White tone
13	Green saturation
14	Saturation

DMX Chart 8 Channels

channel	effect
1	Master dimmer
2	Red
3	Green
4	Blue
5	White
6	Strobe effect
7	Dimmer fine
8	Special functions

DMX Chart 7 Channels

channel	effect
1	Master dimmer
2	Color temperature
3	Green saturation
4	Saturation
5	Hue
6	Dimmer fine
7	Special function

DMX Chart 4 Channels

channel	effect
1	Red
2	Green
3	Blue
4	White

DMX Chart 1 Channels

channel	effect
1	Master dimmer (color temperature settable by display)

Distance (m.)	1	2	3	4	5	6	7	8	9	10
FULL	3884	971	432	243	155	108	79	61	48	39
Luminous emittance (Lux)										
RED	621	155	69	39	25	17	13	10	8	6
GREEN	893	223	99	56	36	25	18	14	11	9
BLUE	231	58	26	14	9	6	5	4	3	2
WHITE	2026	506	225	127	81	56	41	32	25	20
1/2 peak angle ϕ (m.)	1.35	2.70	4.05	5.40	6.75	8.09	9.44	10.79	12.14	13.49
1/10 peak angle ϕ (m.)	3.14	6.28	9.42	12.56	15.70	18.84	21.98	25.11	28.25	31.39

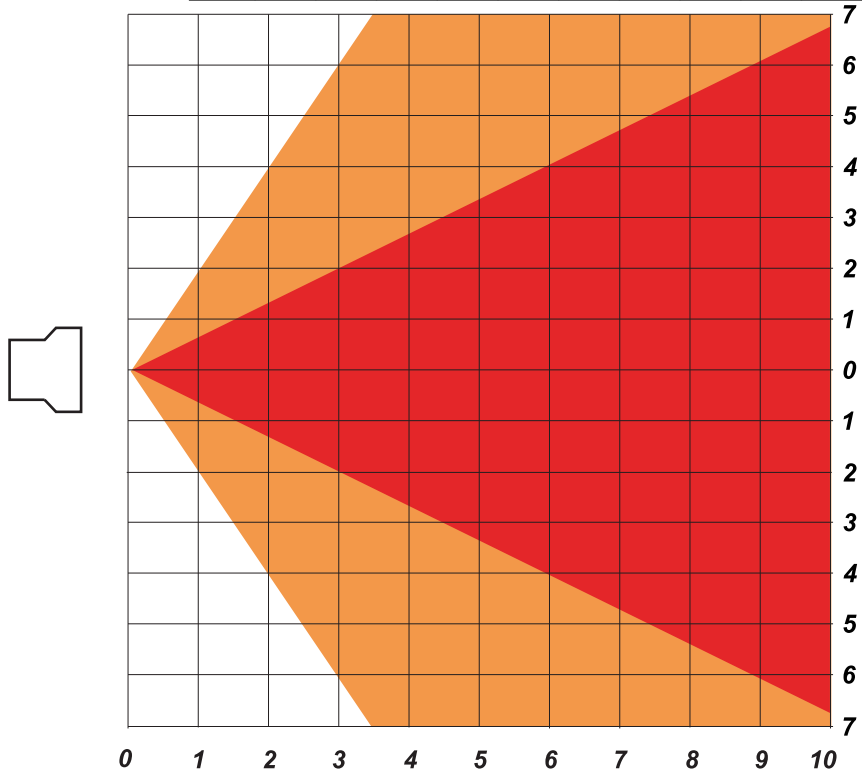

1/2 peak angle: 68°

1/10 peak angle: 115°



Coemar Lighting Srl
Via Carpenedolo, 90
46043 Castiglione delle Stiviere
Mantova - Italy
ph. +39 0376 1514412
fax. +39 0376 1514380

info@coemar.com
www.coemar.com