

Technical Brochure



REFLECTION
EDKO™ FullSpectrum 6

Reflection Series



Reflection LEDko FullSpectrum 6

KEY FEATURES

- Color mixing through 6 colors : Red, Green, Blue, White, Lime, Amber
- 2.700 K - 6.500 K Continuously Variable Correlated Color Temperature with color rendering index greater than 90 (CRI>90)
- Uniform light beam with no multicolor shadows
- Also compatible with new Fresnel and PC optics with shutters (Soft Profile)
- Guaranteed Flicker-free operation (DMX controlled PWM frequency)
- Smooth 16 bit dimmer
- The fan setting allows three options : low, auto, DMX regulated
- Instant gobos from standard printers



Reflection LEDko FullSpectrum 6 - F011H000A

*Reflection LEDko FullSpectrum 6 equipped with PC optic

low power consumption

Reflection LEDko reduces power consumption levels by up to 75% and therefore recovers the financial investment within a few months.

-75%

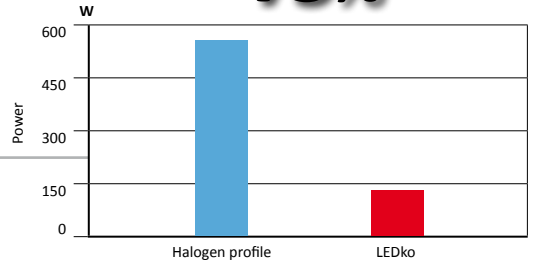

Reflection LEDko FullSpectrum 6

SPECIFICATIONS

Red, Green, Blu, White, Lime, Amber color mixing

CCT: all whites from 2.700 to 6.500 K

Green Magenta adjustment: continuously adjustable (Full Minusgreen to Full Plusgreen)

Four blade framing system, each shutter blade is adjustable for radial position and angle

Electronic 16 bit dimming with 3 selectable curves (exponential, logarithmic, linear)

Synchronized, random or pulse electronic strobe

Flicker-free operation with LEDs frequency controlled via DMX from 600 Hz to 19000 Hz

Fan setting with 3 different options (low, auto, DMX regulated)

CE, ETL, UL approved

Weatherproof rating IP 20

PHYSICAL SIZE (With optic Soft Profile Fresnel)

Length: 601 mm (23.6 in)

Height: 189 mm (7.4 in)

Height with bracket: 372 mm (14.6 in)

Width: 212 mm (8.3 in)

Weight: 8.5 Kg (18.7 lbs)

PHYSICAL SIZE (Without optic)

Length: 362 mm (14.2 in)

Height: 189 mm (7.4 in)

Height with bracket: 372 mm (14.6 in)

Width: 212 mm (8.3 in)

Weight: 6 kg (13.2 lbs)

LIGHT SOURCE

Modular 210 W multiple LEDs , CRI>90

20,000-hour LED life (20,000 hours to 70% intensity)

CONTROL PROTOCOL AND PROGRAMMING

USITT DMX512A

Setting, addressing, testing and measurements via LEDs display

Remote Device Management (RDM)

ELECTRICAL SPECIFICATIONS/CONNECTIONS

AC power: 90-250 V, auto sensing, 50/60 Hz

In and Out PowerCon connectors to feed up to 8 (at 230 VAC) or 4 (90 VAC)

Power consumption: 1.06 A at 230 V, 2.71 A at 90 V - $\cos\phi$ 0,9

DMX data in/out: 5 pin locking XLR

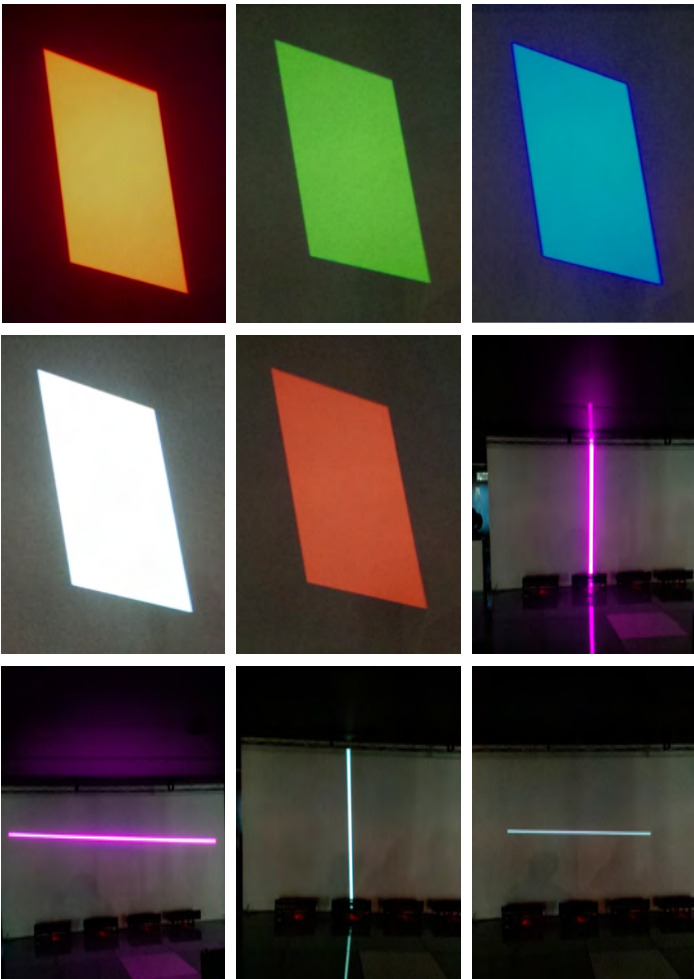

*Framing system with Profile 36° optic

Reflection LEDko FullSpectrum 6 - Optics

Picture	Code	Description
	BC10011A017	Profile Zoom 15°-35°
	BC10011A019	Profile Zoom 25°-50°
	BC10011A003	Profile Zoom 28°-40°
	BC10011A002	Soft Profile Fresnel Zoom 18°- 44°
	BC10011A001	Soft Profile PC Zoom 11°- 38°

Reflection LEDko FullSpectrum 6 - Optics

Picture	Code	Description
	BC10011A200	Front barrel for lens tube with burnished blades
	BC10011A012	Profile 19°, lens tube
	BC10011A013	Profile 26°, lens tube
	BC10011A015	Profile 36°, lens tube
	BC10011A016	Profile 50°, lens tube



Reflection LEDko FullSpectrum 6 - Optics

Picture	Code	Description
	BC10011A023	Profile 14°, lens tube
	BC10011A024	Profile 70°, lens tube
	BC10011A025	Profile 90°, lens tube

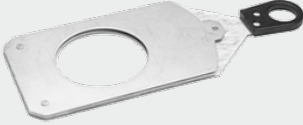
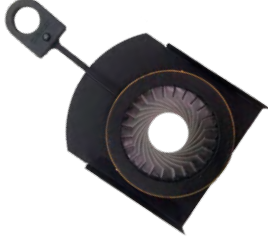

Reflection LEDko FullSpectrum 6 - Accessories

Picture	Code	Description
	<p>ACO4202</p>	<p>4 leaf barndoor</p>
	<p>BC10011A006</p>	<p>Gobo frame holder</p>
	<p>BC10011A030</p>	<p>Gobo glass holder</p>
	<p>BC10011A010</p>	<p>Iris</p>

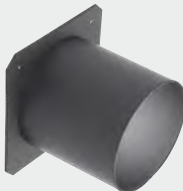
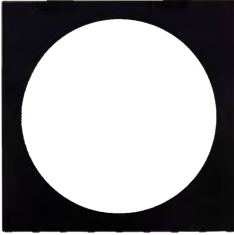
Reflection LEDko FullSpectrum 6 - Accessories

Picture	Code	Description
	BC10011A028 BC10011A036 BC10011A032	Donut for Profile Zoom (190.5 mm) Donut for Soft Profile (185 mm) Donut for Lens Tube (159 mm)
	BC10011A027 BC10011A035 BC10011A031	Half Top Hat for Profile Zoom (190.5 mm) Half Top Hat for Soft Profile (185 mm) Half Top Hat for Lens Tube (159 mm)
	BC10011A029 BC10011A037 BC10011A033	Top Hat for Profile Zoom (190.5 mm) Half Top Hat for Soft Profile (185 mm) Half Top Hat for Lens Tube (159 mm)
	BC10011A040 ACO4204 BC10011A021	Colour Frame Holder for Profile Zoom (190.5 mm) Colour Frame Holder for Soft Profile (185 mm) Colour Frame Holder for Lens Tube (159 mm)

Reflection LEDko FullSpectrum 6 - Accessories

Picture	Code	Description
	BC10011A047	Hook Clamp 48 - 51 mm (Safe Working Load 20 Kg.)
	BC10011A045	Light Clamp silver 48 - 51 mm (Safe Working Load 75 Kg.)
	BC10011A046	Light Clamp black 48 - 51 mm (Safe Working Load 75 Kg.)
	BC10011A043	Clamp silver flat 13 - 30 mm / \varnothing 15 - 50 mm (Safe Working Load: 20 Kg.)
	BC10011A044	Clamp black flat 13 - 30 mm / \varnothing 15 - 50 mm (Safe Working Load 20 Kg.)

Reflection LEDko FullSpectrum 6 - Drawing Size

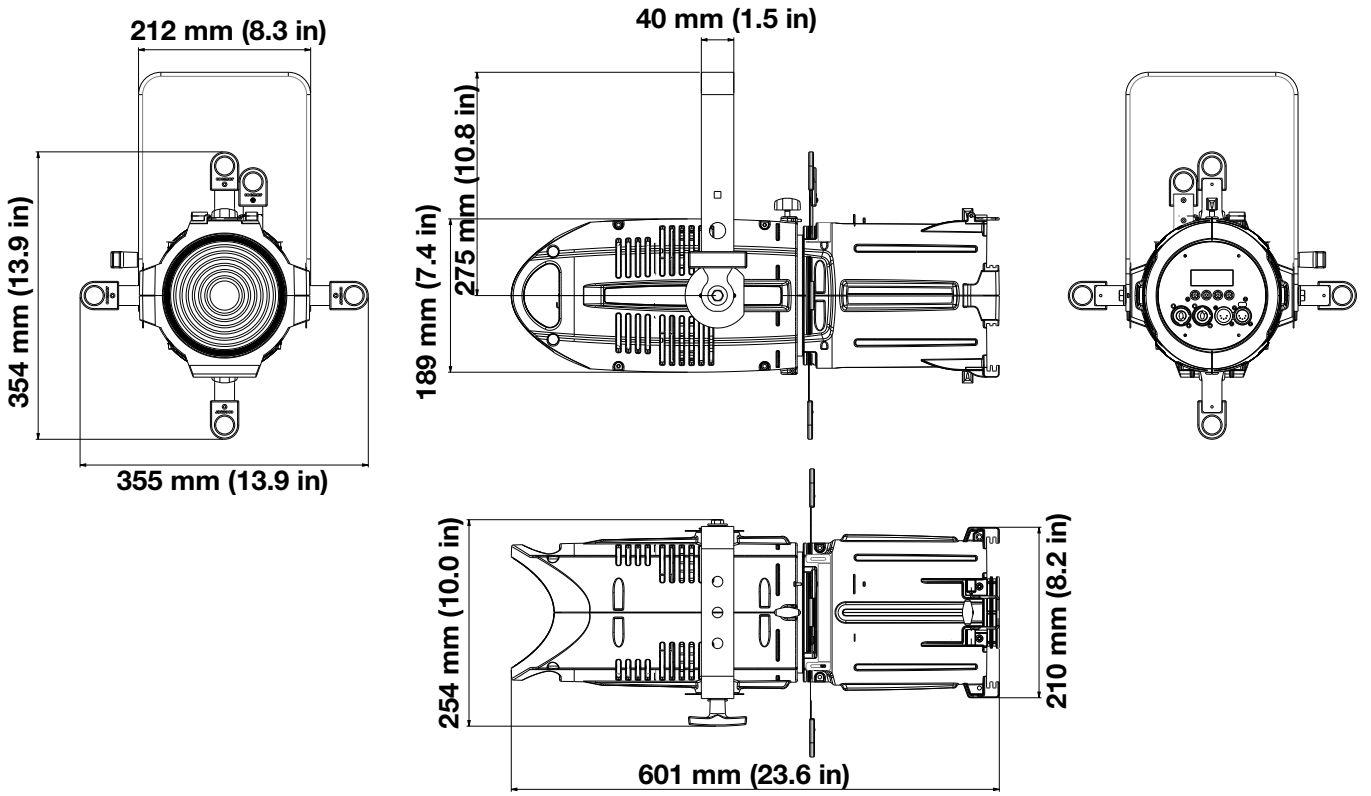

Reflection LEDko with optic Soft Profile Fresnel

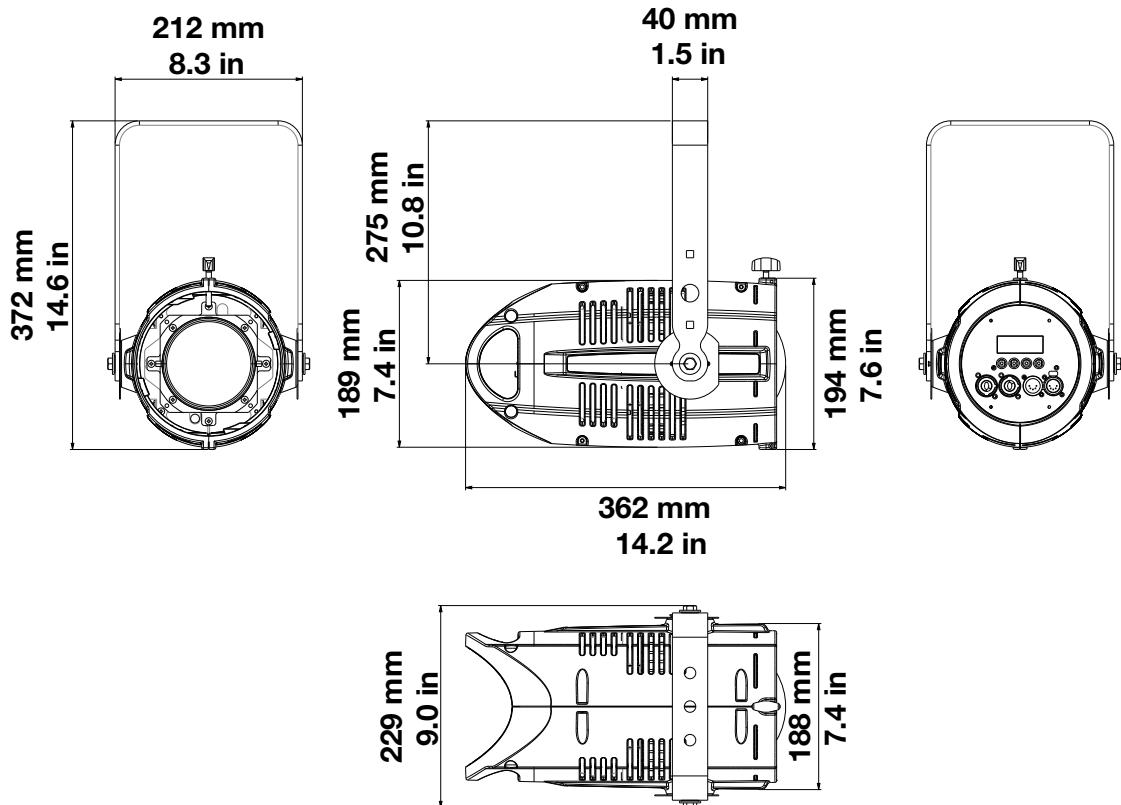

DMX Chart 14 Channels	
channel	effect
1	Master dimmer
2	Red
3	Green
4	Blue
5	White
6	Lime
7	Amber
8	Dimmer fine
9	Special function
10	Red tone
11	Green tone
12	Blue tone
13	White tone
14	Green saturation

DMX Chart 6 Channels	
channel	effect
1	Red
2	Green
3	Blue
4	White
5	Lime
6	Amber

DMX Chart 4 Channels	
channel	effect
1	Master dimmer
2	White tone
3	Green saturation
4	Dimmer fine

DMX Chart 9 Channels	
channel	effect
1	Master dimmer
2	Red
3	Green
4	Blue
5	White
6	Lime
7	Amber
8	Dimmer fine
9	Special function

DMX Chart 1 Channels	
channel	effect
1	Master dimmer (color temperature settable by display)

Reflection LEDko FullSpectrum 6 - CRI/TLCI Chart

CRI/TLCI Chart		
Color temperature	CRI	TLCI
2700 K	91	75.8
3000 K	94	84.4
3200 K	93	80.5
3500 K	95	84.9
4000 K	95	82.8
4500 K	94	79.3
5000 K	93	79.6
5500 K	92	79.6
5600 K	91	78.5
6000 K	90	78.3
6500 K	92	81.8

Reflection LEDko FullSpectrum 6 - Photometric Data

Profile 5°

Distance (m.)	3	6	9	12	15	18	21	24	27	30
RED	13400	3360	1489	838	536	372	273	209	165	134
GREEN	19290	4820	2142	1205	771	536	393	301	238	193
BLUE	3560	890	396	223	142	99	73	56	44	36
WHITE	25080	6270	2787	1568	1003	697	512	392	310	251
LIME	42200	10550	4689	2638	1688	1172	861	659	521	422
AMBER	15480	3870	1720	968	619	430	316	242	191	155
FULL	111600	27900	12400	6975	4464	3100	2278	1744	1378	1116
3200 K	94040	23510	10449	5878	3762	2612	1919	1469	1161	940
5600 K	97600	24400	10844	6100	3904	2711	1992	1525	1205	976
Ø (m.)	0.26	0.52	0.79	1.05	1.31	1.57	1.83	2.10	2.36	2.62

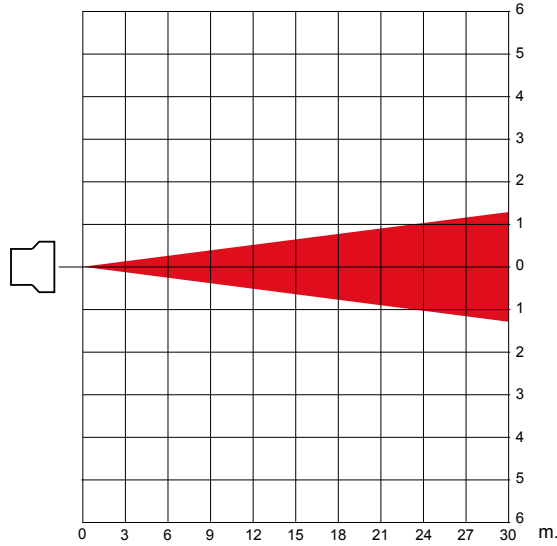

Angle: 5°

Profile 10°

Distance (m.)	3	6	9	12	15	18	21	24	27	30
RED	3599	900	400	225	144	100	73	56	44	36
GREEN	5559	1390	618	347	222	154	113	87	69	56
BLUE	1013	253	113	63	41	29	21	16	13	10
WHITE	6996	1749	777	437	280	194	143	109	86	70
LIME	12196	3049	1355	762	488	339	249	191	151	122
AMBER	4655	1164	517	291	186	129	95	73	57	47
FULL	35389	8847	3932	2212	1416	983	722	553	437	354
3200 K	28257	7064	3140	1766	1130	785	577	442	349	283
5600 K	32013	8003	3557	2001	1281	889	653	500	395	320
Ø (m.)	0.52	1.05	1.57	2.10	2.62	3.15	3.67	4.20	4.72	5.25

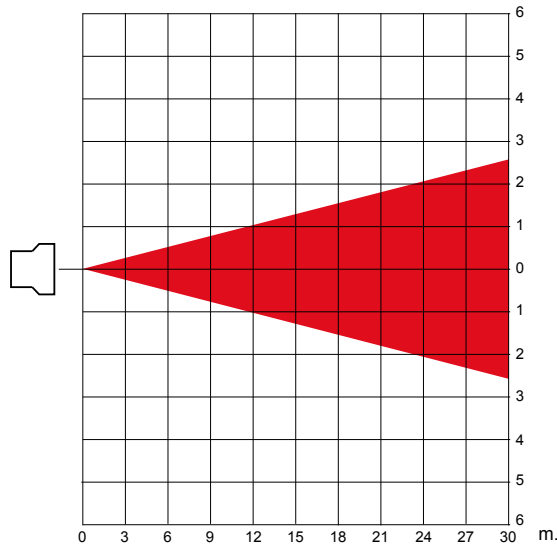

Angle: 10°

Reflection LEDko FullSpectrum 6 - Photometric Data

Profile 14°

Distance (m.)	3	6	9	12	15	18	21	24	27	30
RED	2341	585	260	146	94	65	48	37	29	23
GREEN	3947	987	439	247	158	110	81	62	49	39
BLUE	724	181	80	45	29	20	15	11	9	7
Luminous emittance (Lux)										
WHITE	5009	1252	557	313	200	139	102	78	62	50
LIME	8674	2219	986	555	355	247	181	139	110	89
AMBER	3452	863	384	216	138	96	70	54	43	35
FULL	22622	5655	2514	1414	905	628	462	353	279	226
3200 K	19767	4492	1996	1123	719	499	367	281	222	180
5600 K	20253	5063	2250	1266	810	563	413	316	250	203
Ø (m.)	0.74	1.47	2.21	2.95	3.68	4.42	5.16	5.89	6.63	7.37

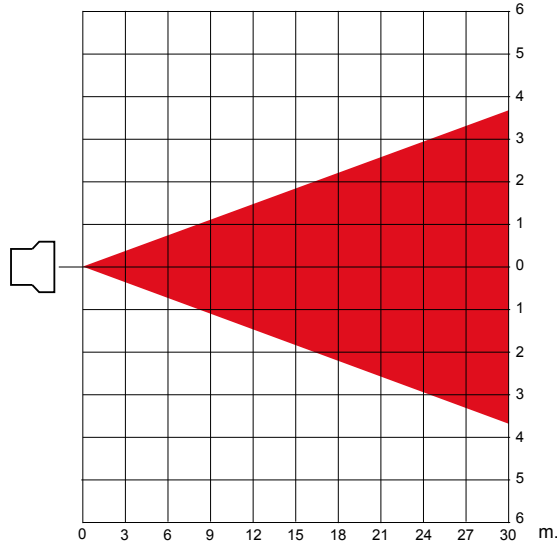

Angle: 14°

Profile 19°

Distance (m.)	3	6	9	12	15	18	21	24	27	30
RED	1307	327	145	82	52	36	27	20	16	13
GREEN	2287	572	254	143	91	64	47	36	28	23
BLUE	397	99	44	25	16	11	8	6	5	4
Luminous emittance (Lux)										
WHITE	2967	742	330	185	119	82	61	46	37	30
LIME	5308	1327	590	332	212	147	109	83	66	53
AMBER	2063	516	229	129	83	57	42	32	25	21
FULL	13339	3335	1482	834	534	371	272	208	165	133
3200 K	10753	2688	1195	672	430	299	219	168	133	108
5600 K	12196	3049	1355	762	488	339	249	191	151	122
Ø (m.)	1.00	2.01	3.01	4.02	5.02	6.02	7.03	8.03	9.04	10.04

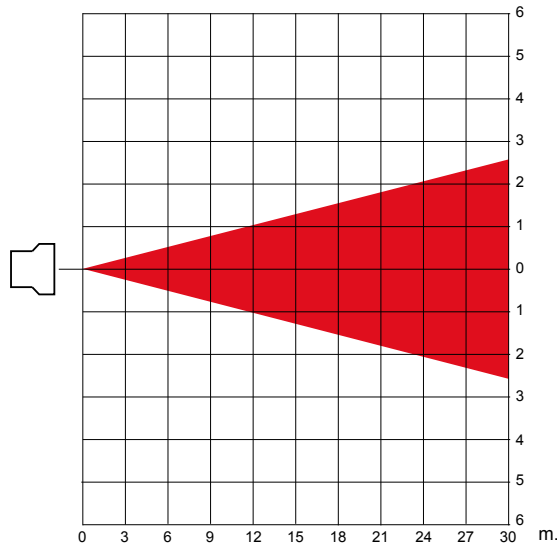

Angle: 19°

Profile 26°

Distance (m.)	1	2	3	4	5	6	7	8	9	10
RED	5390	1348	899	337	216	150	110	84	67	54
GREEN	9800	2450	1089	613	392	272	200	153	121	98
BLUE	1960	490	218	123	78	54	40	31	24	20
Luminous emittance (Lux)										
WHITE	12985	3246	1443	812	519	361	265	203	160	130
LIME	22442	5611	2494	1403	898	623	458	351	277	224
AMBER	8575	2144	953	536	343	238	175	134	106	86
FULL	56350	14088	6261	3522	2254	1565	1150	880	696	564
3200 K	44835	11209	4982	2802	1793	1245	915	701	554	448
5600 K	51450	12863	5717	3216	2058	1429	1050	804	635	515
Ø (m.)	0.46	0.92	1.39	1.85	2.31	2.77	3.23	3.69	4.16	4.62

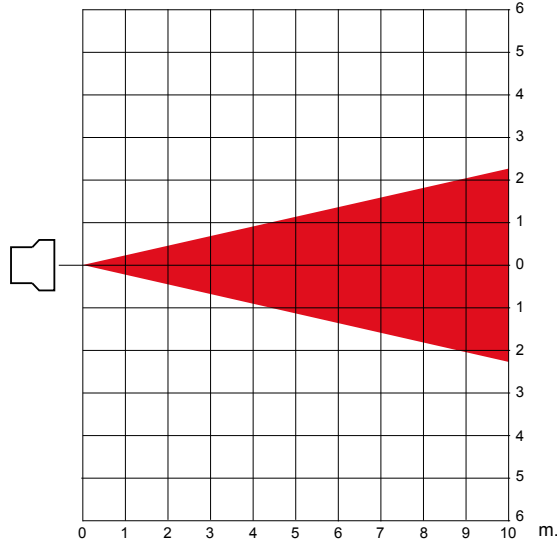

Angle: 26°

Profile 36°

Distance (m.)	1	2	3	4	5	6	7	8	9	10
RED	4018	1005	446	251	161	112	82	63	50	40
GREEN	6027	1507	670	377	241	167	123	94	74	60
BLUE	1076	270	120	67	43	30	22	17	13	11
Luminous emittance (Lux)										
WHITE	7546	1887	838	472	302	210	154	118	93	75
LIME	13475	3369	1497	842	538	374	275	211	166	135
AMBER	5194	1299	577	325	208	144	106	81	64	52
FULL	34300	8575	3811	2144	1372	953	700	536	423	343
3200 K	27881	6970	3098	1743	1115	774	569	436	344	279
5600 K	31066	7767	3452	1942	1243	863	634	485	384	311
Ø (m.)	0.65	1.30	1.95	2.60	3.25	3.90	4.55	5.20	5.85	6.50

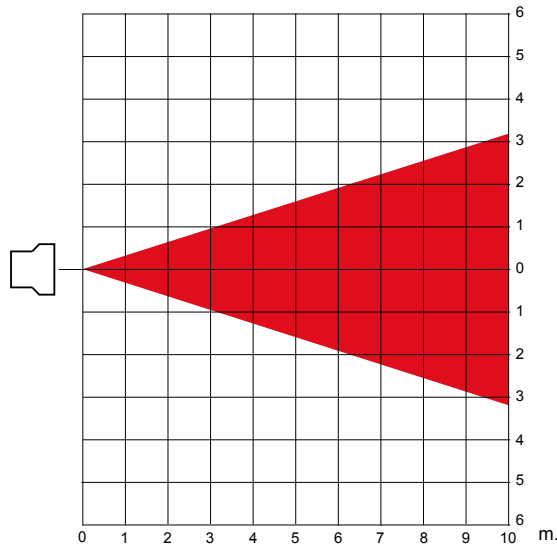

Angle: 36°

Reflection LEDko FullSpectrum 6 - Photometric Data

Profile 50°

Distance (m.)	1	2	3	4	5	6	7	8	9	10
RED	1323	331	147	83	53	37	27	21	16	13
GREEN	2744	686	305	172	110	76	56	43	34	27
BLUE	490	123	54	31	20	14	10	8	6	5
Luminous emittance (Lux)										
WHITE	3528	882	392	221	141	98	72	55	44	35
LIME	6027	1507	670	377	241	167	123	94	74	60
AMBER	2205	551	245	138	88	61	45	34	27	22
FULL	14945	3736	1661	934	598	415	305	234	185	149
3200 K	13671	3418	1519	854	547	380	279	214	169	137
5600 K	12005	3001	1334	750	480	333	245	188	148	120
Ø (m.)	0.93	1.87	2.80	3.73	4.66	5.60	6.53	7.46	8.39	9.33

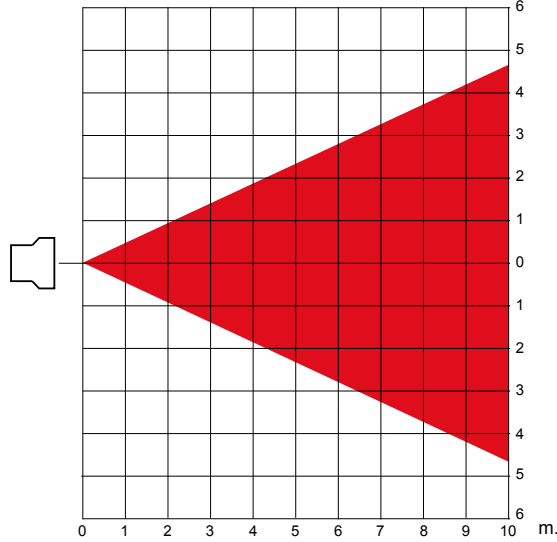

Angle: 50°

Profile 70°

Distance (m.)	1	2	3	4	5	6	7	8	9	10
RED	1078	270	120	67	43	30	22	17	13	11
GREEN	1764	441	196	110	71	49	36	28	22	18
BLUE	343	86	39	21	14	10	7	5	4	3
Luminous emittance (Lux)										
WHITE	2205	551	245	138	88	61	45	34	27	22
LIME	3822	956	425	239	153	106	78	60	47	38
AMBER	1470	368	163	92	59	41	30	23	18	15
FULL	9800	2450	1089	613	392	272	200	153	121	98
3200 K	7840	1960	871	490	314	218	160	123	97	78
5600 K	8967	2242	996	560	359	249	183	140	111	90
Ø (m.)	1.40	2.80	4.20	5.60	7.00	8.40	9.80	11.20	12.60	14.00

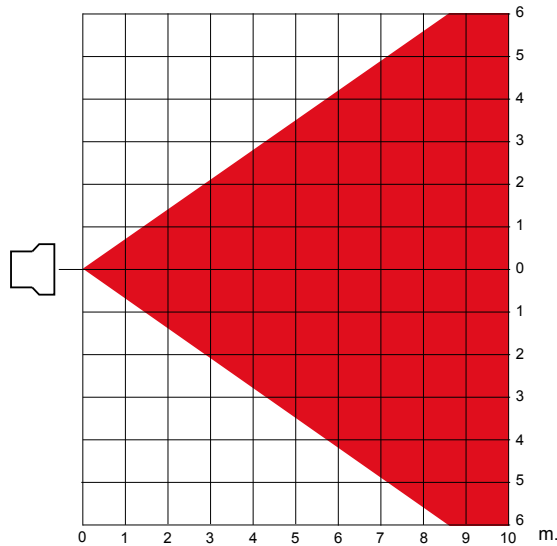

Angle: 70°

Reflection LEDko FullSpectrum 6 - Photometric Data

Profile 15°/35° Zoom min.

Distance (m.)	1	2	3	4	5	6	7	8	9	10
RED	12985	3245	1443	812	519	361	265	203	160	130
GREEN	23765	5941	2641	1485	951	660	485	371	293	238
BLUE	4557	1139	506	285	182	127	93	71	56	46
WHITE	30380	7595	3376	1899	1215	844	620	475	375	304
LIME	50666	12667	5630	3167	2027	1407	1034	792	626	507
AMBER	19110	4778	2123	1194	764	531	390	299	236	191
FULL	122255	30564	13584	7641	4890	3396	2495	1910	1509	1223
3200 K	98000	24500	10889	6125	3920	2722	2000	1531	1210	980
5600 K	112700	28175	12522	7044	4508	3131	2300	1761	1391	1127
∅ (m.)	0.26	0.53	0.79	1.05	1.32	1.58	1.84	2.11	2.37	2.63

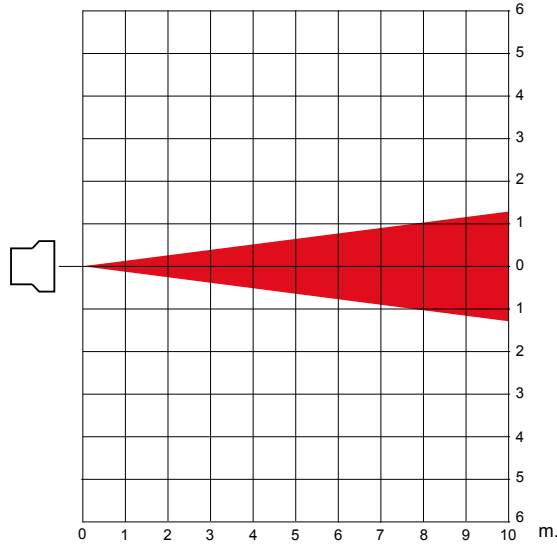

Angle: 15°

Profile 15°/35° Zoom med.

Distance (m.)	1	2	3	4	5	6	7	8	9	10
RED	6174	1544	686	386	247	172	126	96	76	62
GREEN	10241	2560	1138	640	410	284	209	160	126	102
BLUE	1362	456	207	116	74	52	38	29	23	19
WHITE	12740	3185	1416	796	510	354	260	199	157	127
LIME	22235	5574	2477	1393	892	619	455	348	275	223
AMBER	8330	2083	926	521	333	231	170	130	103	83
FULL	66640	16660	7404	4165	2666	1851	1360	1041	823	666
3200 K	53410	13353	5934	3338	2136	1484	1090	835	659	534
5600 K	60270	15068	6697	3767	2411	1674	1230	942	744	603
∅ (m.)	0.43	0.85	1.28	1.70	2.13	2.55	2.98	3.40	3.83	4.25

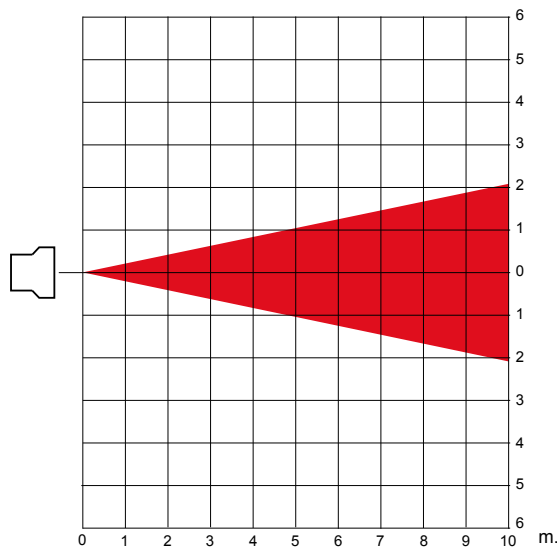

Angle: 24°

Reflection LEDko FullSpectrum 6 - Photometric Data

Profile 15°/35° Zoom max.

Distance (m.)	1	2	3	4	5	6	7	8	9	10
RED	3773	943	419	236	151	105	77	59	47	38
GREEN	5880	1470	653	365	235	163	120	92	73	59
BLUE	1029	257	114	64	41	29	21	16	13	10
WHITE	7252	1813	806	453	290	201	148	113	90	73
LIME	12593	3148	1399	787	504	350	257	197	155	126
AMBER	4851	1213	539	303	194	135	98	76	60	49
FULL	38220	9555	4247	2389	1529	1062	780	597	472	382
3200 K	30870	7718	3430	1929	1235	858	630	482	381	309
5600 K	35280	8820	3920	2205	1411	980	720	561	436	353
Ø (m.)	0.59	1.18	1.78	2.37	2.96	3.55	4.15	4.74	5.33	5.92

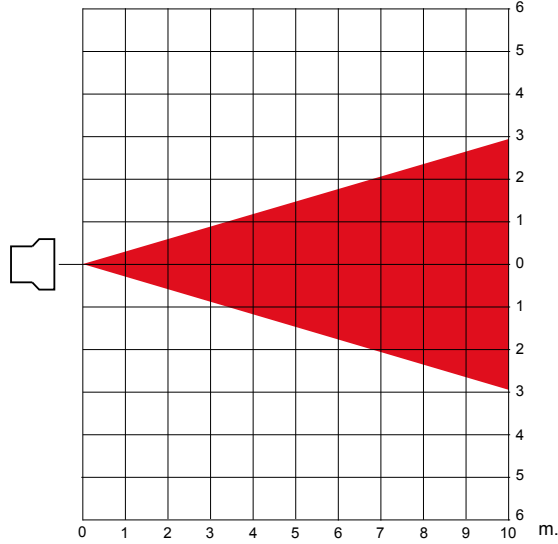

Angle: 33°

Profile 25°/50° Zoom min.

Distance (m.)	1	2	3	4	5	6	7	8	9	10	
RED	3724	931	414	233	149	103	76	58	46	37	
GREEN	7203	1801	800	450	288	200	147	113	89	72	
BLUE	1470	368	163	92	59	41	30	23	18	15	
WHITE	9506	2377	1056	594	380	264	194	149	117	95	
Luminous emittance (Lux)	LIME	16464	4116	1829	1029	659	457	336	257	203	165
	AMBER	6223	1556	691	389	249	173	127	97	77	62
	FULL	46060	11515	5118	2879	1842	1279	940	720	569	461
	3200 K	36995	9248	4111	2312	1480	1028	755	578	457	370
	5600 K	42140	10535	4682	2634	1686	1171	860	656	520	421
	∅ (m.)	0.50	1.00	1.50	1.99	2.49	2.99	3.49	3.99	4.49	4.99

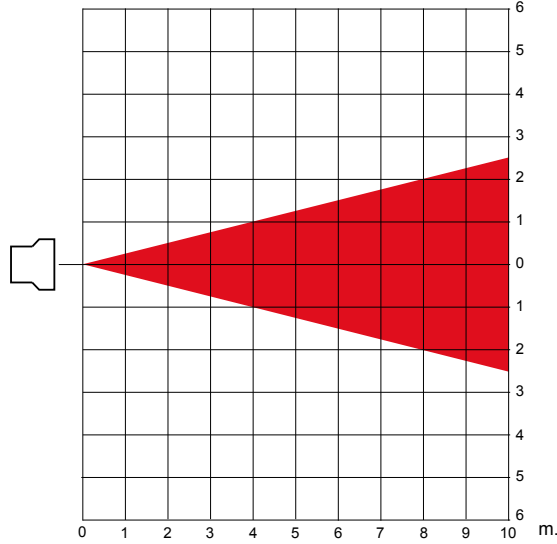

Angle: 28°

Profile 25°/50° Zoom med.

Distance (m.)	1	2	3	4	5	6	7	8	9	10	
RED	3185	796	354	199	127	88	65	50	39	32	
GREEN	7105	1776	789	444	284	197	145	111	86	71	
BLUE	1372	343	152	86	55	39	29	21	17	14	
WHITE	9163	2291	1018	573	367	255	187	143	113	92	
Luminous emittance (Lux)	LIME	15925	3981	1769	995	637	442	325	249	197	159
	AMBER	5929	1482	659	371	237	165	121	93	73	59
	FULL	26950	6738	2994	1684	1078	749	550	421	333	270
	3200 K	21560	5390	2396	1348	862	599	440	337	266	216
	5600 K	24843	6211	2760	1553	994	690	507	388	307	248
	∅ (m.)	0.67	1.34	2.01	2.68	3.35	4.02	4.68	5.35	6.02	6.69

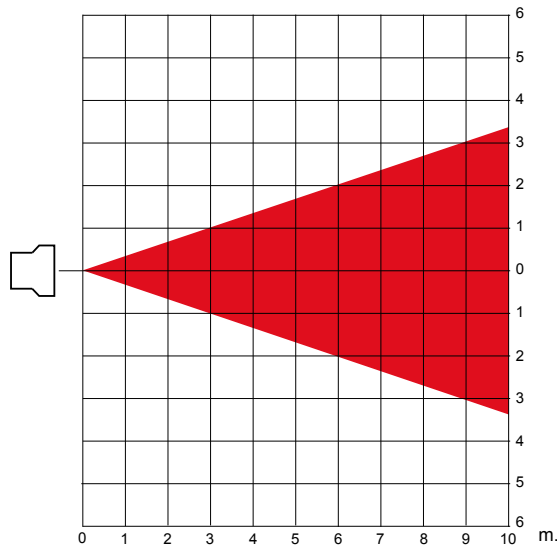

Angle: 37°

Reflection LEDko FullSpectrum 6 - Photometric Data

Profile 25°/50° Zoom max.

Distance (m.)	1	2	3	4	5	6	7	8	9	10
RED	1666	417	185	104	67	46	34	26	21	17
GREEN	3185	796	354	199	127	88	65	50	39	32
BLUE	588	147	65	37	24	16	12	9	7	6
WHITE	4165	1041	463	260	167	116	85	65	51	42
LIME	7350	1838	817	459	294	204	150	115	91	74
AMBER	2744	686	305	172	110	76	56	43	34	27
FULL	19110	4778	2123	1194	764	531	390	299	236	191
3200 K	15386	3847	1710	962	615	427	314	240	190	154
5600 K	17640	4410	1960	1103	706	490	360	276	218	176
Ø (m.)	0.87	1.74	2.61	3.48	4.35	5.22	6.09	6.96	7.83	8.70

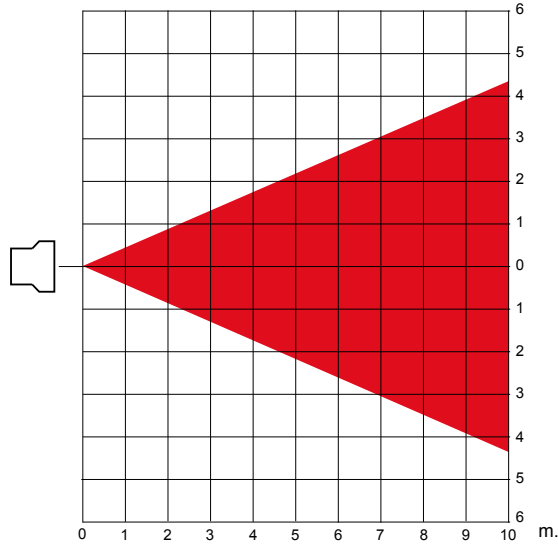

Angle: 47°

Profile 28°/40° Zoom min.

Distance (m.)	1	2	3	4	5	6	7	8	9	10
RED	5145	1286	572	322	206	143	105	80	64	51
GREEN	8330	2083	926	521	333	231	170	130	103	83
BLUE	1470	368	163	92	59	41	30	23	18	15
WHITE	10045	2511	1116	628	402	279	205	157	124	100
LIME	17983	4496	1998	1124	719	500	367	281	222	180
AMBER	6860	1715	762	429	274	191	140	107	85	69
FULL	45570	11393	5063	2848	1823	1266	930	712	563	456
3200 K	35770	8943	3974	2236	1431	994	730	559	442	358
5600 K	42140	10535	4662	2634	1696	1171	860	656	520	421
∅ (m.)	0.48	0.96	1.44	1.92	2.40	2.88	3.36	3.84	4.32	4.80

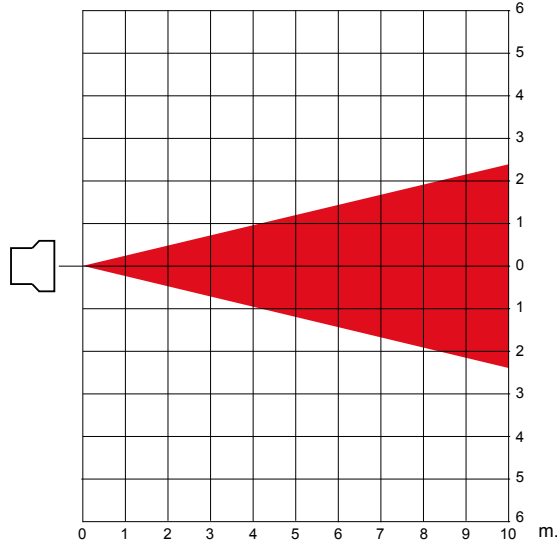

Angle: 27°

Profile 28°/40° Zoom med.

Distance (m.)	1	2	3	4	5	6	7	8	9	10
RED	3185	796	354	199	127	88	65	50	39	32
GREEN	4900	1225	544	305	196	136	100	77	60	49
BLUE	880	245	109	61	39	27	20	15	12	10
WHITE	6468	1617	719	404	259	180	132	101	80	65
LIME	11319	2830	1258	707	453	314	231	177	140	113
AMBER	4165	1041	463	260	167	116	85	65	51	42
FULL	28910	7228	3212	1807	1156	803	590	452	357	289
3200 K	22687	5672	2521	1418	907	630	463	354	280	227
5600 K	26460	6615	2940	1654	1058	735	540	413	327	265
∅ (m.)	0.65	1.30	1.95	2.60	3.25	3.90	4.55	5.20	5.85	6.50

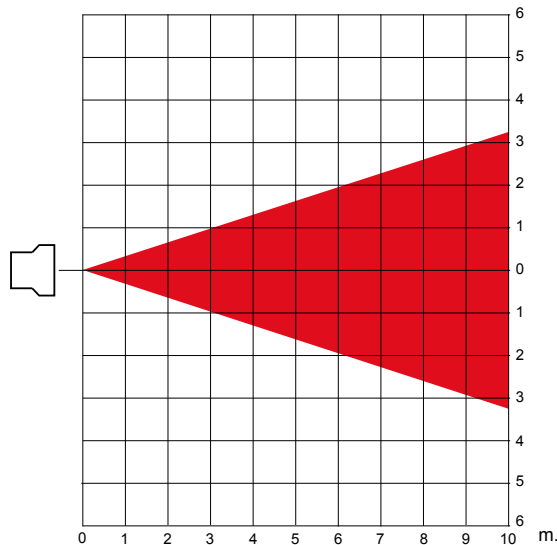

Angle: 36°

Reflection LEDko FullSpectrum 6 - Photometric Data

Profile 28°/40° Zoom max.

Distance (m.)	1	2	3	4	5	6	7	8	9	10
RED	2205	551	245	138	88	61	45	34	27	22
GREEN	3920	980	436	245	157	109	80	61	48	39
BLUE	735	184	82	46	29	20	15	11	9	7
WHITE	4900	1225	544	306	196	136	100	77	60	49
Luminous emittance (Lux)										
LIME	8820	2205	980	551	353	245	180	138	109	88
AMBER	3430	858	381	214	137	95	70	54	42	34
FULL	22246	5562	2472	1390	890	618	454	348	275	222
3200 K	18032	4508	2004	1127	721	501	368	282	223	180
5600 K	20590	5145	2287	1286	823	572	420	322	254	205
Ø (m.)	0.83	1.66	2.49	3.31	4.14	4.97	5.80	6.63	7.46	8.28

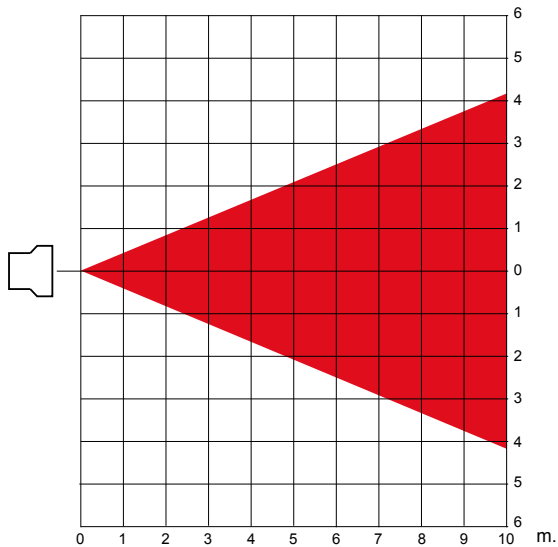

Angle: 45°

Soft Profile F Zoom min.

Distance (m.)	1	2	3	4	5	6	7	8	9	10	
RED	3675	919	408	230	147	102	75	57	45	37	
GREEN	7595	1899	844	475	304	211	155	119	94	76	
BLUE	1470	368	163	92	59	41	30	23	18	15	
Luminous emittance (Lux)	WHITE	9408	2352	1045	588	376	261	192	147	116	94
	LIME	15974	3994	1775	998	639	444	326	250	197	160
	AMBER	5929	1482	656	371	237	165	121	93	73	59
	FULL	42140	10535	4682	2634	1686	1171	860	658	520	421
	3200 K	33810	8453	3757	2113	1352	939	690	528	417	338
	5600 K	39200	9800	4356	2450	1568	1089	800	613	484	392
1/2 peak angle θ (m.)	0.32	0.63	0.95	1.27	1.58	1.90	2.22	2.53	2.85	3.17	
1/10 peak angle θ (m.)	0.52	1.03	1.55	2.07	2.59	3.10	3.62	4.14	4.66	5.17	

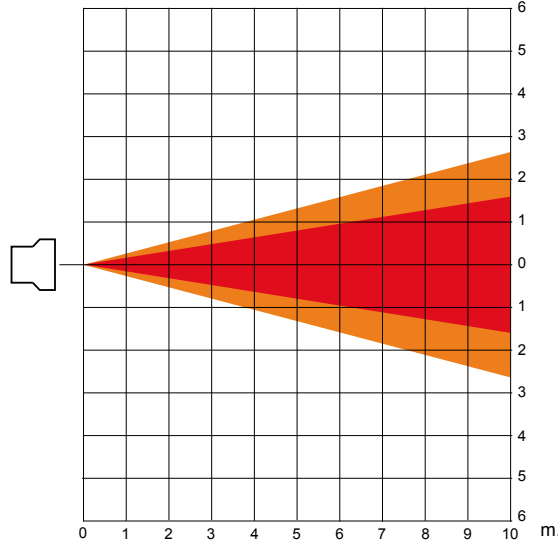

1/2 peak angle: 18°

1/10 peak angle: 29°

Soft Profile F Zoom max.

Distance (m.)	1	2	3	4	5	6	7	8	9	10	
RED	2460	613	272	153	98	68	50	38	30	25	
GREEN	4753	1188	528	297	190	132	97	74	59	48	
BLUE	931	233	103	58	37	26	19	15	11	9	
Luminous emittance (Lux)	WHITE	5978	1495	664	374	239	166	122	93	74	60
	LIME	10094	2524	1122	631	404	280	206	158	125	101
	AMBER	3724	931	414	233	149	103	76	58	46	37
	FULL	29645	7411	3294	1853	1186	823	605	463	366	296
	3200 K	23765	5941	2641	1485	951	660	485	371	293	238
	5600 K	27342	6836	3038	1709	1094	760	559	427	338	273
1/2 peak angle θ (m.)	0.52	1.03	1.55	2.07	2.59	3.10	3.62	4.14	4.66	5.17	
1/10 peak angle θ (m.)	0.81	1.62	2.42	3.23	4.04	4.85	5.66	6.46	7.27	8.08	

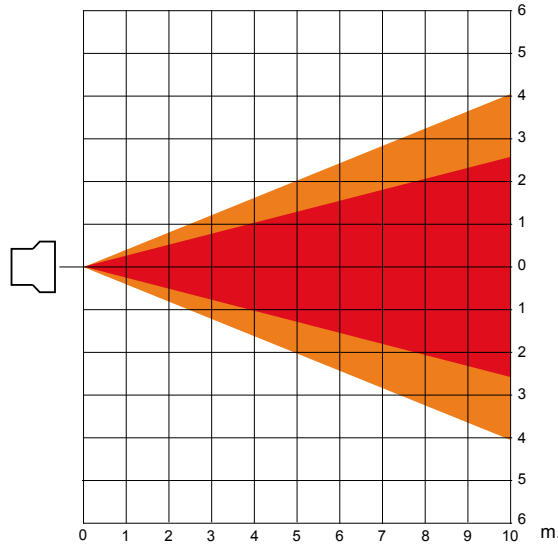

1/2 peak angle: 29°

1/10 peak angle: 44°

Reflection LEDko FullSpectrum 6 - Photometric Data

Soft Profile PC Zoom min.

Distance (m.)	1	2	3	4	5	6	7	8	9	10
RED	6125	1531	681	383	245	170	125	96	76	61
GREEN	10094	2524	1122	631	404	280	206	158	125	101
BLUE	1715	429	191	107	69	48	35	27	21	17
WHITE	12495	3124	1388	781	500	347	255	195	154	125
Luminous emittance (Lux)	LIME 21560	5390	2396	1348	862	599	440	337	266	216
	AMBER 8085	2021	898	505	323	225	165	126	100	81
	FULL 54880	13720	6098	3430	2195	1524	1120	858	678	549
	3200 K 44345	11086	4927	2772	1774	1232	905	693	547	443
	5600 K 50960	12740	5662	3185	2038	1416	1040	796	629	510
1/2 peak angle θ (m.)	0.19	0.39	0.58	0.77	0.96	1.16	1.35	1.54	1.73	1.93
1/10 peak angle θ (m.)	0.37	0.74	1.11	1.48	1.85	2.22	2.59	2.97	3.34	3.71

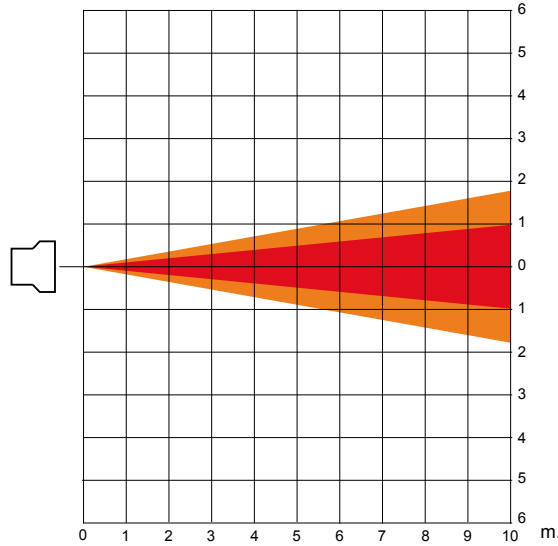

1/2 peak angle: 11°

1/10 peak angle: 21°

Soft Profile PC Zoom max.

Distance (m.)	1	2	3	4	5	6	7	8	9	10
RED	3038	760	338	190	122	84	62	47	38	30
GREEN	5145	1286	572	322	206	143	105	80	64	51
BLUE	833	208	93	52	33	23	17	13	10	8
WHITE	6615	1654	735	413	265	184	135	103	82	66
Luminous emittance (Lux)	LIME 11270	2818	1252	704	451	313	230	176	139	113
	AMBER 4214	1054	468	263	169	117	86	66	52	42
	FULL 33320	8330	3702	2083	1333	926	680	521	411	333
	3200 K 26705	6676	2967	1669	1068	742	545	417	330	267
	5600 K 30625	7656	3403	1914	1225	851	625	479	378	306
1/2 peak angle θ (m.)	0.39	0.78	1.17	1.56	1.94	2.33	2.72	3.11	3.50	3.89
1/10 peak angle θ (m.)	0.89	1.38	2.07	2.75	3.44	4.13	4.82	5.51	6.20	6.89

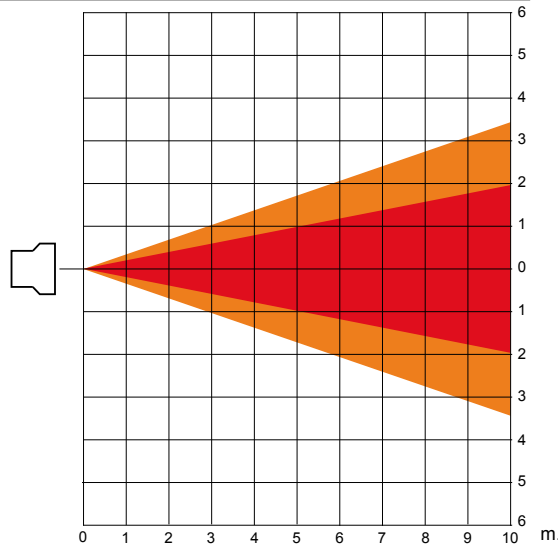

1/2 peak angle: 22°

1/10 peak angle: 38°



Coemar Lighting S.r.l.

Via Carpenedolo, 90
46043 Castiglione delle Stiviere
Mantova - Italy
ph. +39 0376 1514412
fax +39 0376 1514380

www.coemar.com

Coemar Lighting S.r.l. reserves the right to change specifications without prior notice.