

coemar

SoftLite LED VariWhite +

Product code:
F126G000A

Last update:
06/03/2023

softLite LED



SoftLite LED VariWhite +

Introducing

● **SoftLite Led**, the 250 W diffuse led light projector equipped with the revolutionary and unique reflected illumination system. Thanks to its innovative optical system, SoftLite Led delivers an extremely uniform output with incredibly soft shadows and a perfect color mixing (RBGW version): this is the reason why this fixture is considered the perfect LED replacement for traditional cyclorama or fill lights.

SoftLite Led provides **different DMX control modes** to allow the quick setup of the fixture in various application situations and a smooth **16 bit dimming** with a choice of **5 curve options available** (linear, logarithmic, exponential, halo and standard). The PWM frequencies can be adjusted from 600 up to 20.000 Hz either on board or via DMX for **flickerfree performance** and this makes the SoftLite Led the perfect tool for **professional lighting** both in **broadcast and theatre applications**. The extruded aluminum and steel housing integrates 4 different fan speed setting (silent, studio, auto, DMX regulated), that enables a low noise operation while a bright LED display permits an easy and intuitive configuration. **The double dissipation system** with air forced efficient heat pipe cooling and the adjustable fan ensure optimum operation without any danger of overheating. The fixture comes with either a manual or pole operated yoke. A set of accessories is also available to allow the control of the beam. Available in three different versions: **RGBW, Tungsten and VariWhite**.

Key Features



● 96 Cree LEDs VariWhite



● High CRI > 95



● CCT proportional control 2.700K → 6.500K



● Reflection technology for a fully uniform illumination



● Beam angle: horizontal 62° (1/2 peak angle) 110° (1/10 peak angle), vertical 54° (1/2 peak angle) 92° (1/10 peak angle)



● Aluminium extruded and steel body



● Custom color on request (optional)







● Manual (standard) or Pole Operated Pan-Tilt (Optional)



● European Conformity certification

General	
● LED Source	96 Cree LEDs VariWhite
● CCT Range	●●●●● Proportional control 2.700K → 6.500K
● Color Rendition Average	CRI>95 , TLC ~ 98
● Dimming	8 or 16 bit, 5 selectable curves: Exponential, Logarithmic, Linear, Halo and Standard
● Strobe	Synchronized, random or pulse electronic strobe
● Available Optics	Horizontal 62° (1/2 peak angle) 110° (1/10 peak angle), vertical 54° (1/2 peak angle) 92° (1/10 peak angle)
● Camera flicker control/Hz range	Guaranteed flicker-free operation with LEDs frequency controlled via DMX from 600 to 20.000 Hz
● Calibrated Cob	Yes
● L80 Rating (hours to 80% output)	50.000 Hours
Electrical	
● Voltage Input	90-264V, 50/60 Hz, auto-sensing
● Power Consumption	250W Maximum 1.1 A at 230 V, 2.22 A at 115 V - cosφ 0,98
● Power Connection	In and Out PowerCON TRUE1 Top connectors, 1,5 m. detachable POWERCON power cable with bare ends
● Data Connection	In and Out DMX 5 pin locking XLR connectors
Thermal	
● Ambient Operating Temperature	0°C - +40°C (32°F - 104°F)
● Fan (controllable)	Yes, 4 different settings: Silent, Studio, Auto, DMX Regulated
Control	
● Protocols	DMX-512, RDM (Remote Device Management), Wireless (optional By LumenRadio)
● RDM configuration	Yes
● DMX Channels	5 / 2 / 1
● Display	Graphic OLED with on-board selector for quick setting
● Firmware upgrade	Through DMX with RDM Upgrade USB interface (code AC10011A001)
Physical	
● Mounting Options	Yoke (Manual or Pole Operated), 2 ground-standing feet
● Materials	Aluminium extruded and steel body
● Weight	9.6 Kg / 21.16 lbs
● Length	620 mm / 24.41 in
● Height	210.5 mm / 8.28 in - With bracket: 264.5 mm / 10.41 in
● Width	200mm / 7.87 in
● IP Rating	IP20 (available IP65 version)
● Color options	Black (standard), custom color on request (optional)
General accessories	
BC10026A002	4 leaf barndoor
BC10026A007	4 leaf barndoor intensifier + asymmetric diffuser
BC10026A008	Pole Operated Yoke
BC10026A001	Color frame holder
BC10026A003	Honeycomb (6 mm) - 1/2 peak angle 7° -1/10 peak angle 13°
BC10026A004	Honeycomb (10mm) - 1/2 peak angle 10° -1/10 peak angle 16°
BC10026A005	Honeycom XL
BC10026A006	Soft diffuser (Differend filters available)
PCO80052/1	2 ground standing feet

BC10026A002	4 leaf barndoor	
BC10026A007	4 leaf barndoor intensifier + asymmetric diffuser	
BC10026A008	Pole Operated Yoke	
BC10026A001	Color frame holder	
BC10026A003	Honeycomb - 6 mm / 0.24 in - 1/2 peak angle 7°	
BC10026A004	Honeycomb - 10 mm / 0.39 in - 1/10 peak angle 16°	
BC10026A005	Honeycomb XL	

PC08052/1	2 ground standing feet	
BC10026A006	Soft diffuser (different filter available)	



SoftLite LED with various accessories

DMX Charts

6 Channels

- 01 → Master Dimmer
- 02 → Dimmer Fine
- 03 → White Tone
- 04 → Fine White Tone
- 05 → Strobe Effect
- 06 → Special Functions

2 Channels

- 01 → Master Dimmer
- 02 → White Tone

1 Channel

- 01 → Master Dimmer - Color Temperature Settable by Display

Drawing Size

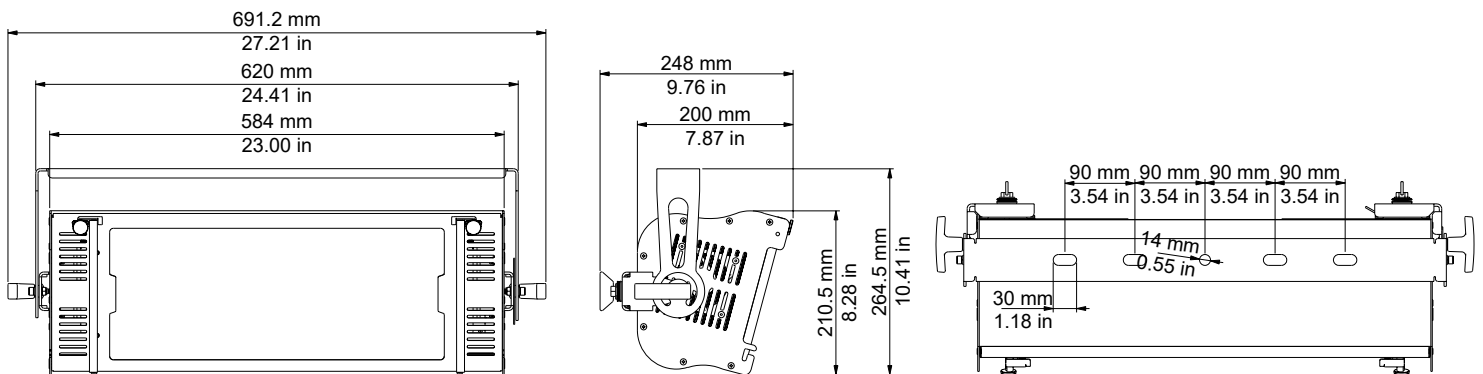

SoftLite LED VariWhite

Optic: Horizontal Beam

Distance(m)	1	2	3	4	5	6	7	8	9	10
2.800K	1.962	491	218	123	78	55	40	31	24	20
3.200K	2.322	581	258	145	93	65	47	36	29	23
lux 4.000K	2.385	596	265	149	95	66	49	37	29	24
5.600K	2.673	668	297	167	107	74	55	42	33	27
6.500K	2.673	668	297	167	107	74	55	42	33	27
1/2 P.A. Ø (m)	1,20	2,40	3,61	4,81	6,01	7,21	8,41	9,61	10,82	12,02
1/10 P.A. Ø (m)	2,86	5,71	8,57	11,43	14,28	17,14	19,99	22,85	25,71	28,56

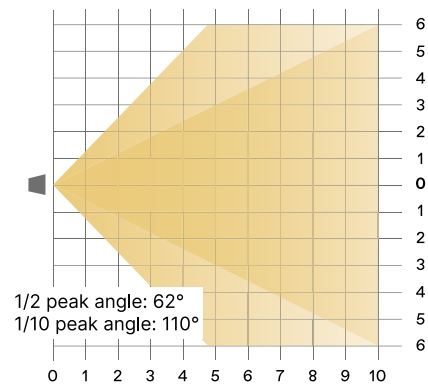

Optic: Vertical Beam

Distance(m)	1	2	3	4	5	6	7	8	9	10
2.800K	1.962	491	218	123	78	55	40	31	24	20
3.200K	2.322	581	258	145	93	65	47	36	29	23
lux 4.000K	2.385	596	265	149	95	66	49	37	29	24
5.600K	2.673	668	297	167	107	74	55	42	33	27
6.500K	2.673	668	297	167	107	74	55	42	33	27
1/2 P.A. Ø (m)	1,02	2,04	3,06	4,08	5,10	6,11	7,13	8,15	9,17	10,19
1/10 P.A. Ø (m)	2,07	4,14	6,21	8,28	10,36	12,43	14,50	16,57	18,64	20,71

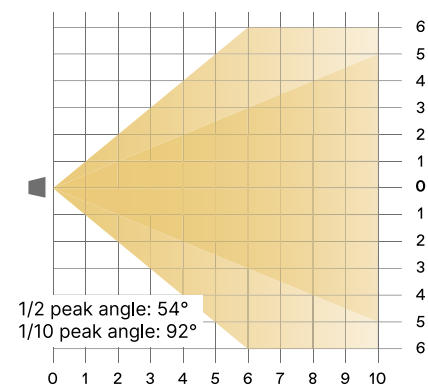

● Coemar Lighting S.r.l.

Via Carpenedolo, 90
46043, Castiglione delle Stiviere (MN) – Italy

P. +39 0376 1514412

M1. info@coemar.com

M2. service@coemar.com

W. coemar.com

P.iva – C.f. 02415330204

